

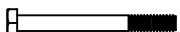



GATE HARDWARE CORPORATION

GATE WHEEL ASSEMBLY

Dear Customer:

Thank you for purchasing one of our high quality wheel assemblies for vinyl gates. We are confident this product will provide you with a lifetime of continued service. As with all of our hardware, this product is made from corrosion resistant stainless steel. Please take a moment to ensure you have received all of the hardware:

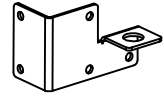
- | | |
|---|--|
| <p>A  (4) – 1/4" Stainless Bolt</p> <p>B  (4) – 1/4" Stainless Hex Nut</p> <p>C  (4) – 1/4" Stainless Flat Washer</p> | <p>D  (10) – #14 Stainless Slotted Sheet Metal Screw</p> <p>E  (2) – Stainless Drop Rod Guide Bracket</p> |
|---|--|

INSTALL GUIDE BRACKETS **E ONLY IF YOU INTEND TO USE A DROP ROD WITH YOUR GATE DROP ROD SOLD SEPARATELY.**

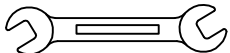

 USE A 3/8" WRENCH/NUT DRIVER FOR A #14 SHEET METAL SCREW. WRENCH NOT INCLUDED.

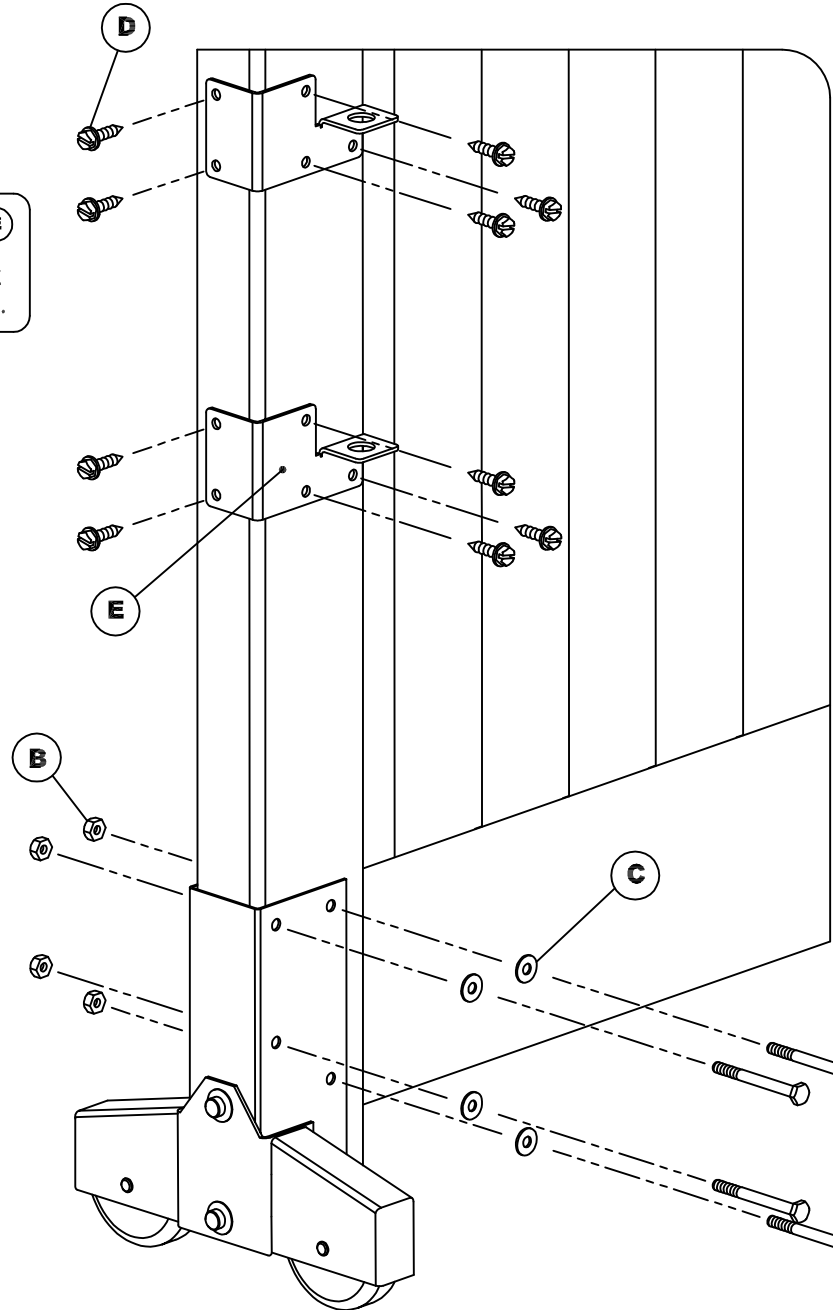
 USE A 7/16" WRENCH FOR A 1/4" BOLT/NUT WRENCH NOT INCLUDED.



 PRE-DRILL HOLES FOR SCREW **D** WITH A 3/16" DIAMETER DRILL BIT.

CAUTION!
 REMEMBER SAFETY FIRST! USE RECOMMENDED SAFETY GEAR SUCH AS EYE PROTECTION AND GLOVES WHEN INSTALLING THIS PRODUCT.

 PRE-DRILL HOLES FOR SCREW **A** WITH A 1/4" DIAMETER DRILL BIT.